

tinyvision.ai

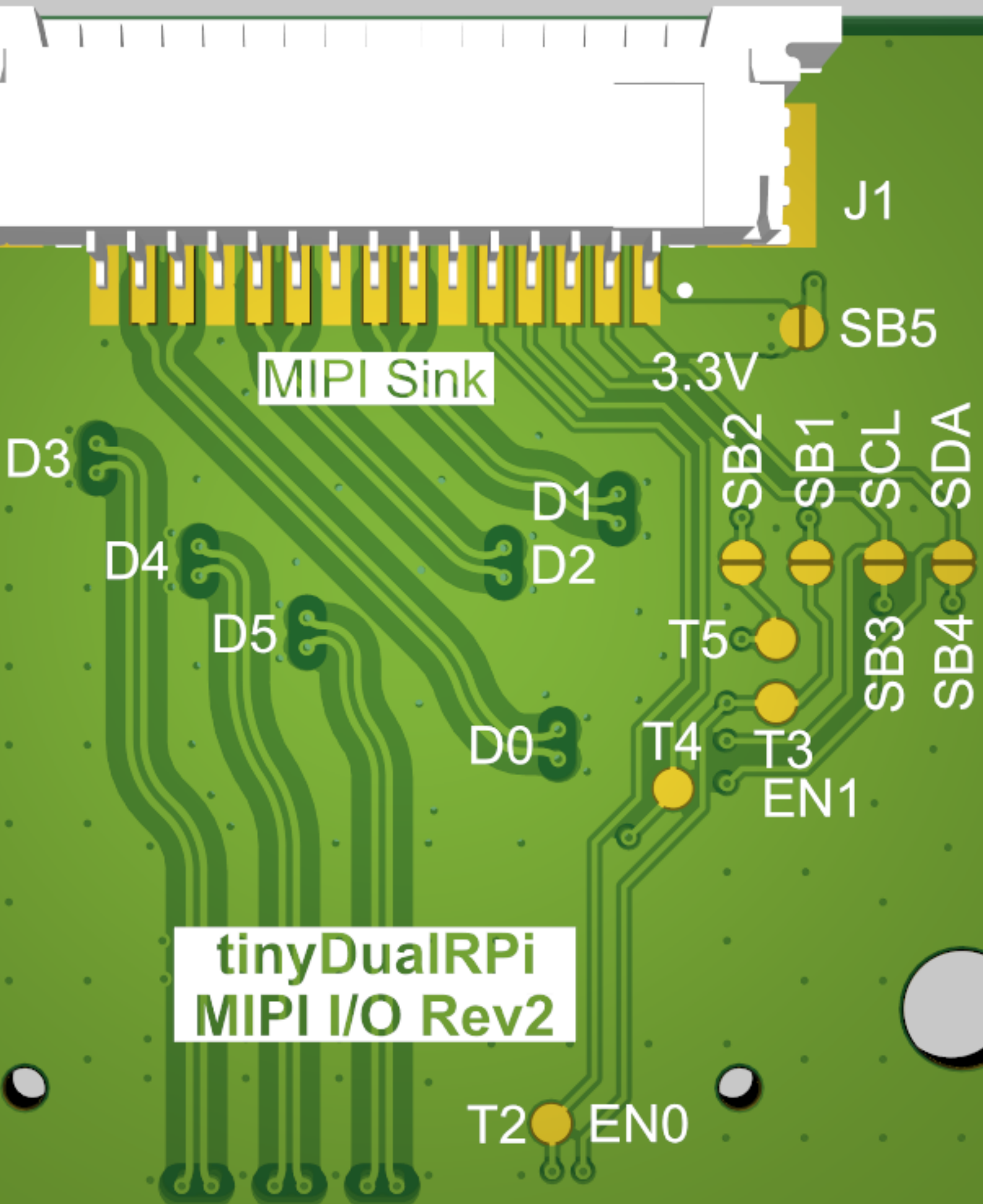

tinyDualRPi
MIPI I/O Rev2



J1

MIPI Sink

3.3V

SB5

D3

D1

SB2

SB1

SCL

SDA

D4

D2

D5

T5

T4

SB3

SB4

D0

T4

T3

EN1

T2

EN0

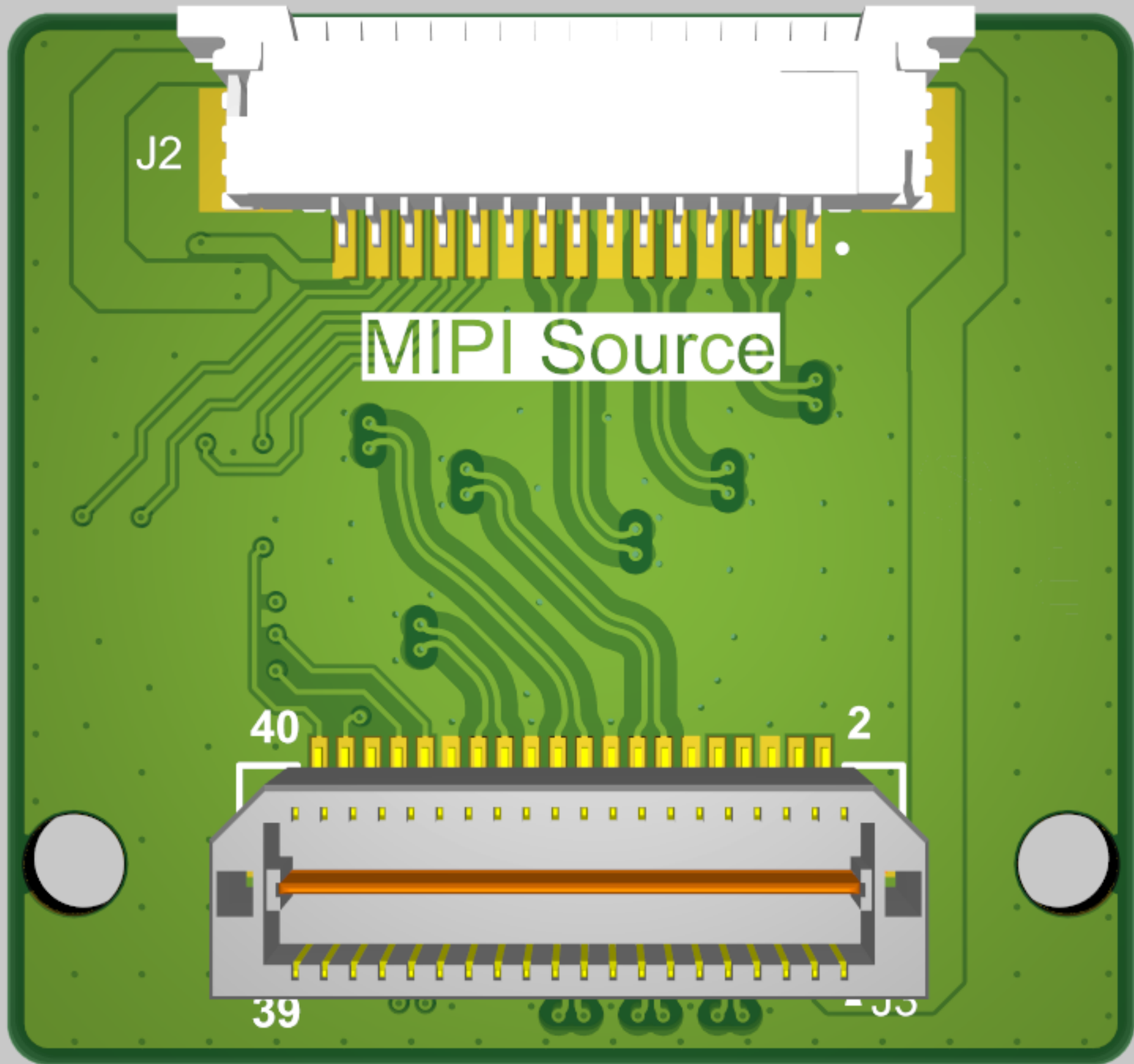

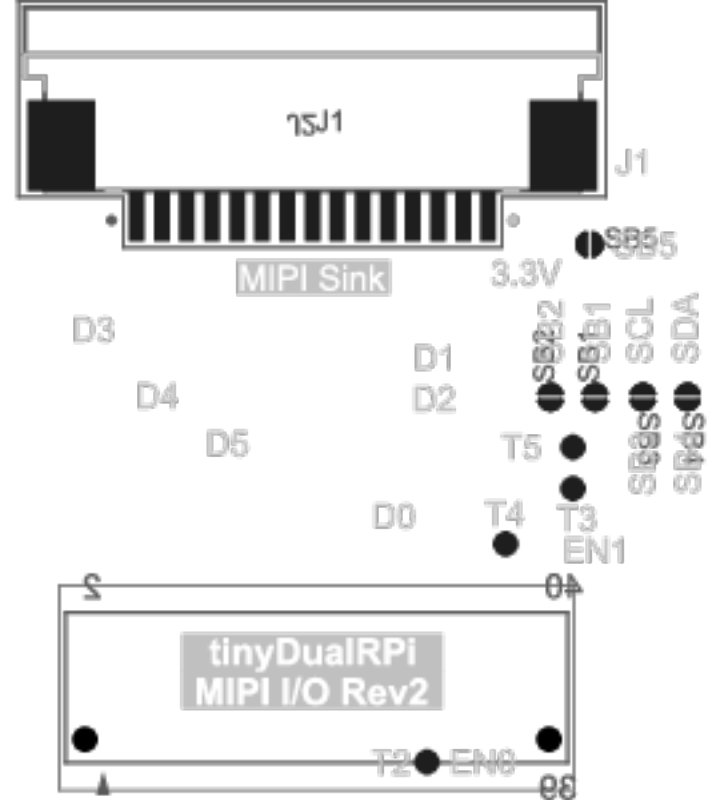

TOP SILKSCREEN
BOARD ASSEMBLY

BOTTOM SILKSCREEN

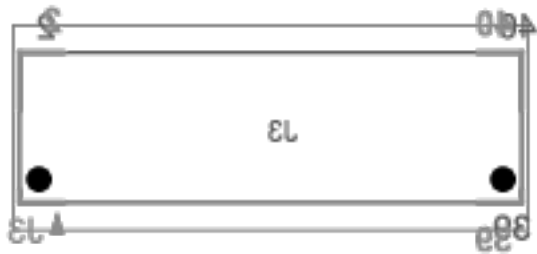

- ØSB4
- ØSB3
- ØSB1
- ØSB2

MIP1 Source

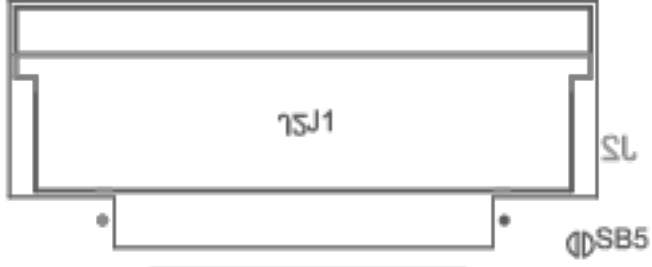

BOTTOM SILKSCREEN

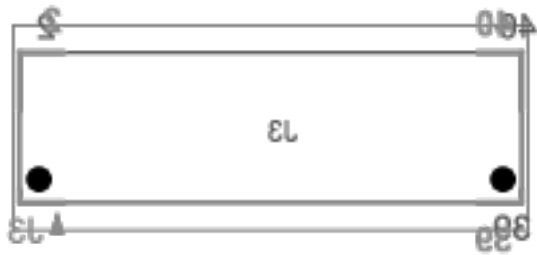

ØSB4
ØSB3
ØSB1
ØSB2

MIP1 SOURCE



BOARDSOURCE BY BOTTOM SILKSCREEN

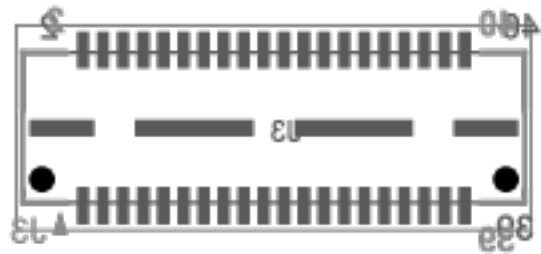

- ⌀SB2
- ⌀SB1
- ⌀SB3
- ⌀SB4

