

tiny SoM Developer Kit

v2.0



tinyvision.ai

Pod B

Pod A

DATA

DEBUG

CKSEL

GPIO

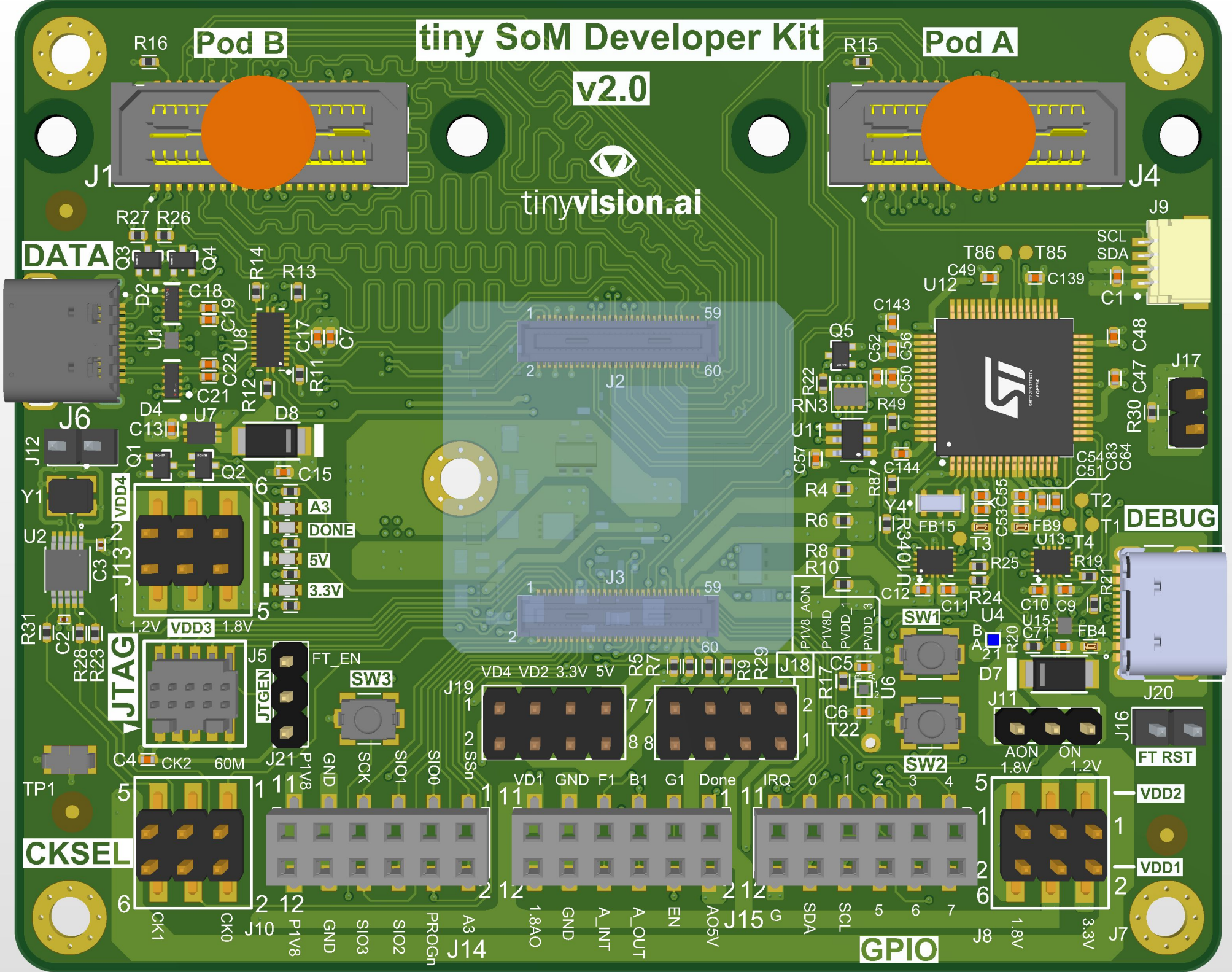

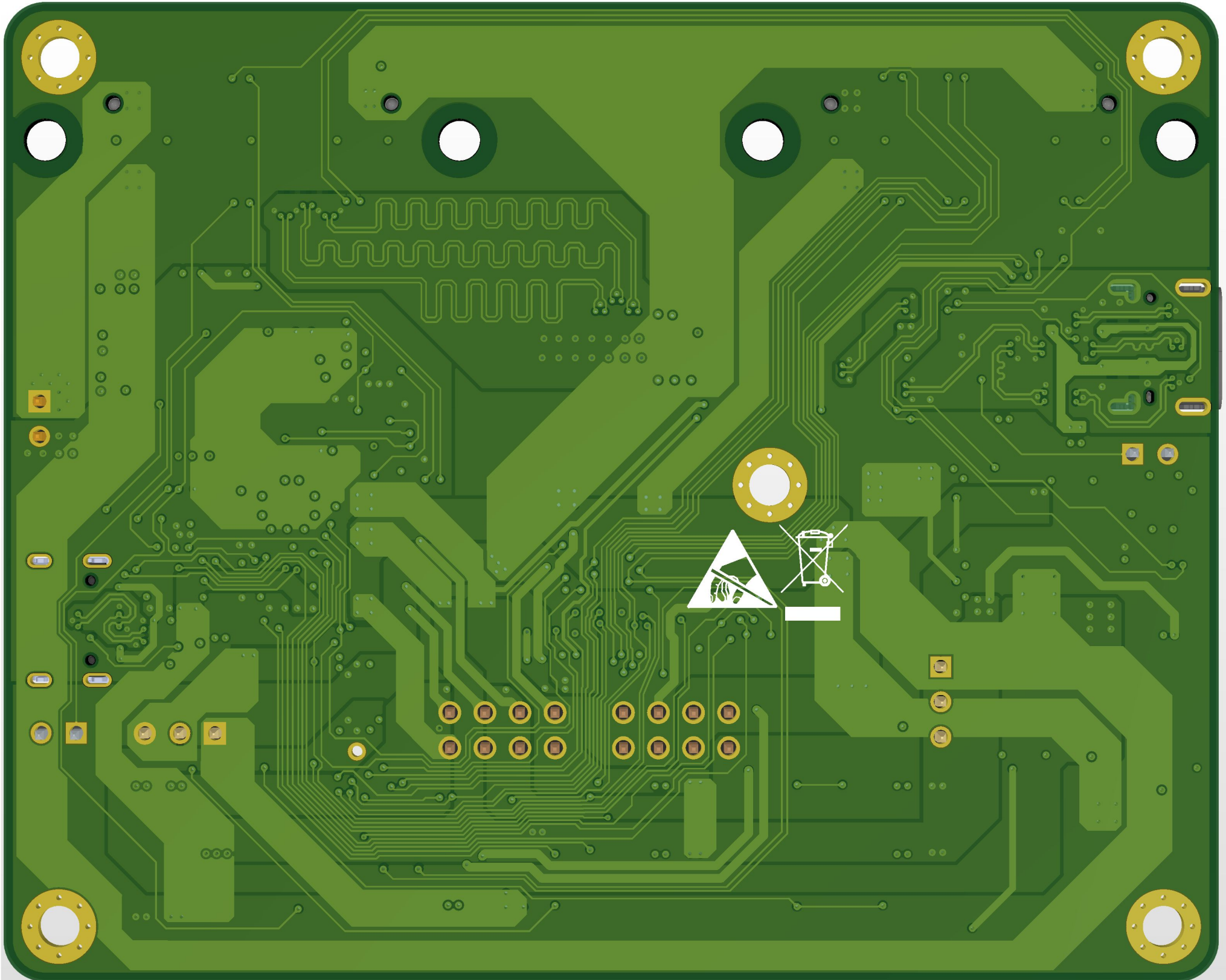

BH4

BH2

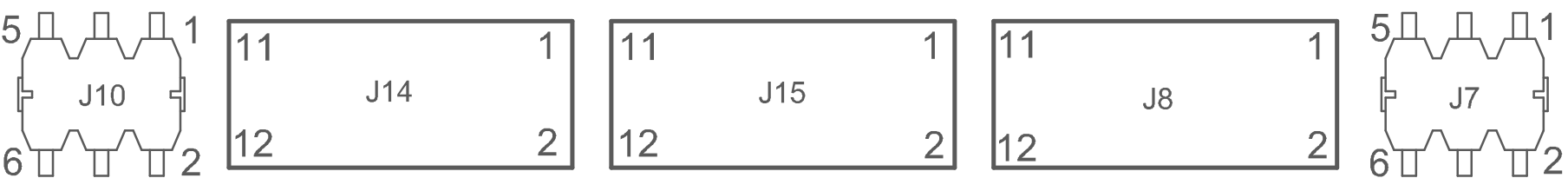
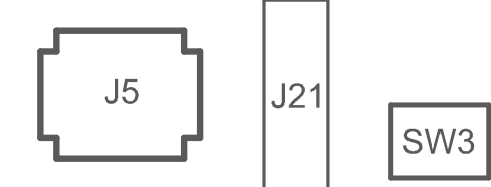
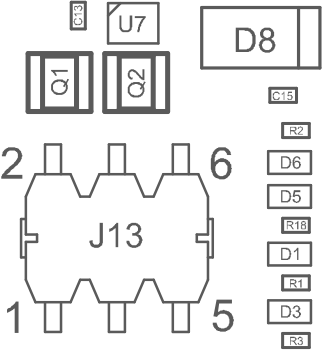
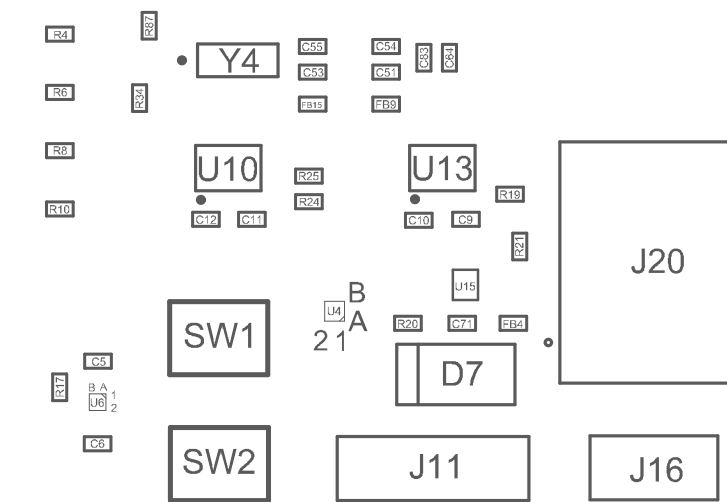
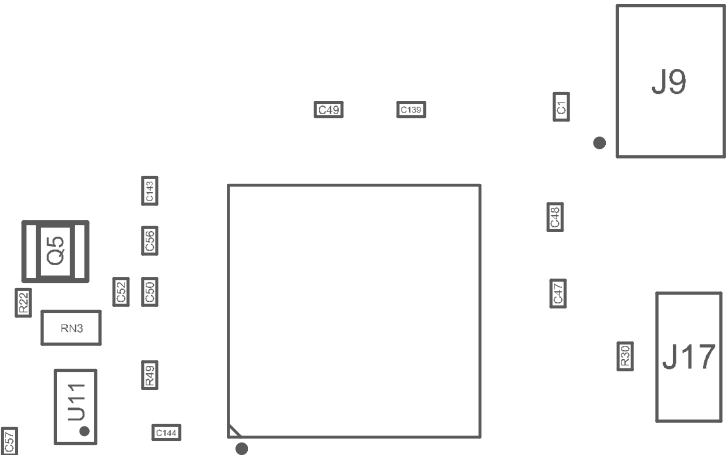
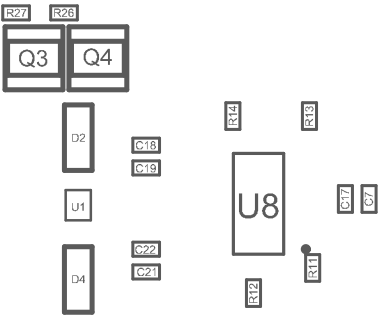

BH3

BH1

ASSEMBLY TOP

PCB Edge